

Data Sheet



Article number: 604133044055

Description: Taper bored timing belt pulley
HTD 44 14M 55 TL 3020

Measures

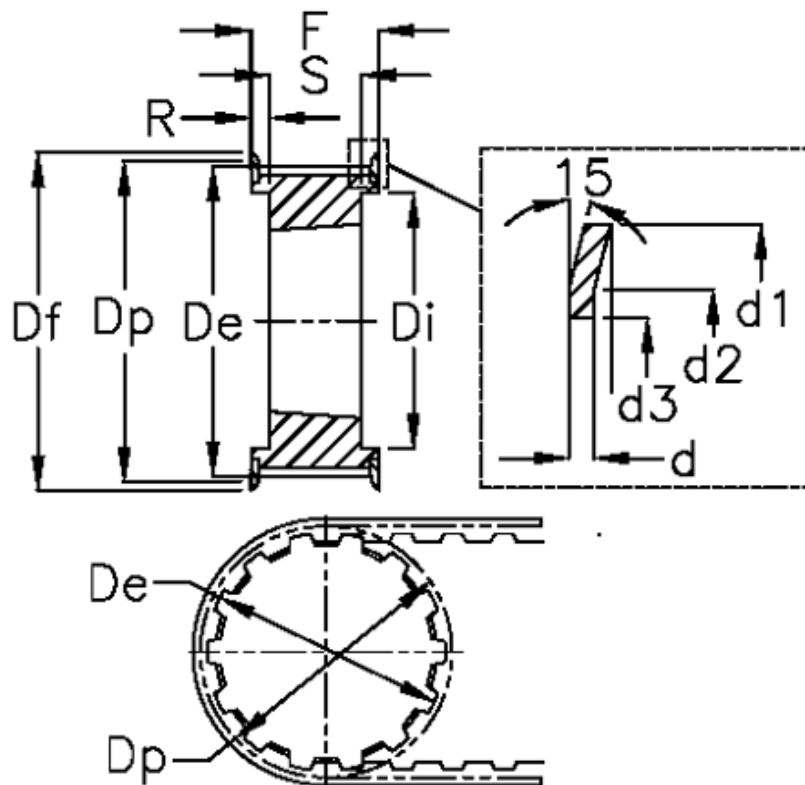

d = 2.5	F = 70	Weight = 8.6
d1 = 212	Flange type = F61	Width = 55
d2 = 200	For bushing = 3020	
d3 = 162	Max bore = 75	
De = 193.28	r = 9.5	
Df = 212	S = 51	
Di = 155	Tooth number = 44	
Dp = 196.08	Type = 14M	